

**PBF**  
Hydraulic  
Press Brakes

Series



Easy  
to Use

Faster

Productive

Winning

Ergonomic



As a total supplier for sheet metal manufacturing with almost 70 years of experience, Durma understands and recognizes the challenges, requirements and expectations of the industry. We strive to satisfy the ever higher demands of our customers by continuously improving our products and processes while researching and implementing the latest technologies

In our three production plants with a total of 150.000 m<sup>2</sup>, we dedicate 1,000 employees to delivering high quality manufacturing solutions at the best performance-to-price ratio in the market.



**PRODUCTION IS**  
**MORE EFFECTIVE** NOW



From the innovations developed at our Research & Development Center to the technical support given by our worldwide distributors, we all have one common mission: to be your preferred partner.

**Durmazlar offers it's machines to the world markets under the Durma brand.**



**1**

High technology,  
modern production  
lines



**2**

Top quality  
components

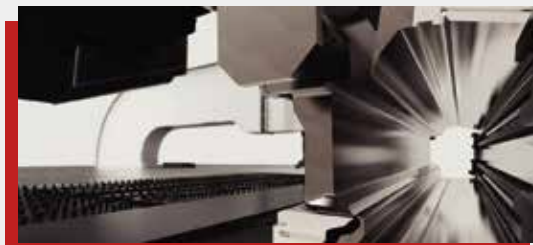

**3**

High quality  
machines designed  
in R&D Centre

# PBF

## **PBF Series Press Brakes**

### **Customer-oriented**

We designed an excellent machine for our clients who do not need high stroke and work in three shifts. We support you with low investment costs, efficient, precise, minimum maintenance costs.

PBF series serves your company and advances your production standards.



Production is **More Effective Now.**



## The "Magic Touch" for your company

- Fast, productive and perfect bendings
- High efficiency
- Low energy consumption

## Perfectly equipped for precise bendings and economic solutions

Developed by the expertise of R&D Center engineers of DURMAZLAR  
PBF Hydraulic Press Brake will strengthen your business with innovative solutions.



### Advantages

- Better and faster bendings
- Rigid body structure
- High sensitivity and repeatability
- Low maintain cost
- Hi-tech equipment
- Increases the value of your company
- Reliable brand



## GAIN MORE

## POWER

Easy solutions for your investments

PBF Hydraulic Press Breaks, featuring low investment cost, high productivity and perfect performance / price ratio, ensures and obtains all

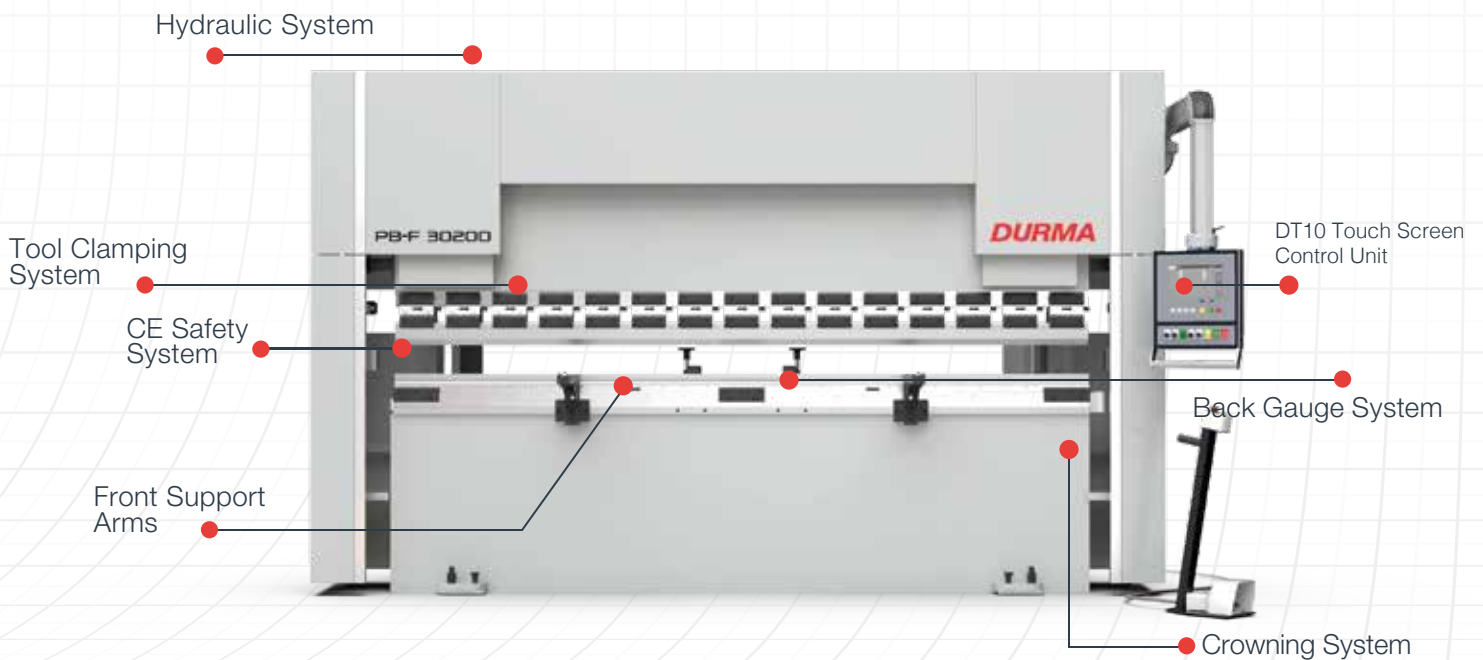

### General Specifications

- High sensitivity, Stress relieved steel construction body, long life Mono Block Frame
- DURMA designed and copyrighted guiding system
- Ball Screw and linear guide integrated perfect back gauge system
- Durable, long life and sensitive bending capable special hardened top tools
- Suitable for segmented tools special and fast tool holding system
- Sensitive solutions at long and deep bending
- High accuracy linear scales
- CE safety standards
- Environment friendly, efficient and perfect bending combinations



Production is *More Effective Now.*

# STRONG BACK GAUGE SYSTEM

- **Precise**
- **Reliable**
- **Strong**

- Fast and high precision
- Reliable process
- Adjustable from each point
- Crash-proof
- Maintenance free



## Why DURMA Back Gauge ?

Most important feature to achieve perfect bending is the stability and the design of the back gauge, which allows an impeccable and correct product to be produced.

The high speed **ballscrew** back gauge system movement is also supported with **double linear guides**, which helps the back gauge achieve long life, greater sensitivity and strengthens against any collisions.

Special designed finger blocks with steps to achieve maximum stability can also be supplied for every kind of bending solution.

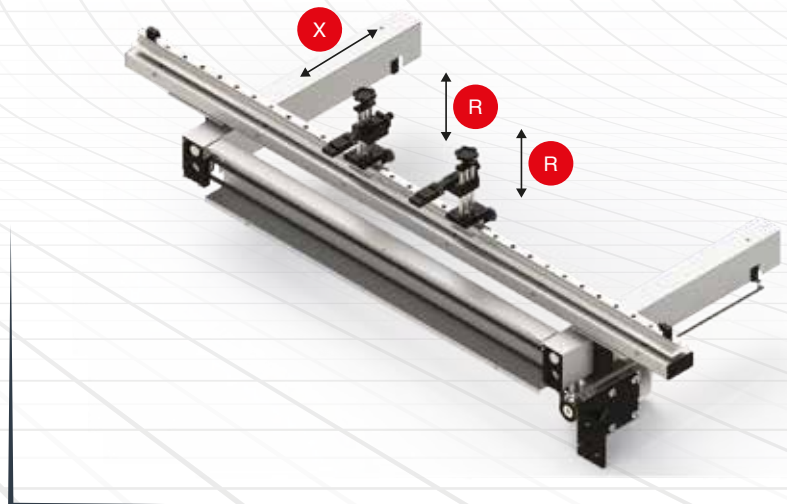

Standard back gauge  
X=500 Back gauge system with: motorized & linear guide & ballscrew  
R manual adjustment

## TOOL HOLDERS AND TOOLS

Bending performance is increased with high European clamping system and easiness to use. Narrow table for Z bending ( a press brake operation that makes two equal and opposite bend ) and table designed for European style tool holder.

DURMA is your solution partner with various tool options.



European Clamping System

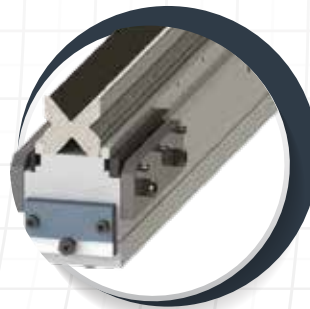

European Type Bottom Tool (4V Die)



Quick Release Clamping



DURMA Multi V Bottom Tool



## SAFE AND ACCURATE BENDS WITH TOP QUALITY EQUIPMENTS

### ■ Crowning System

Manual or CNC-controlled motorized crowning system simplifies bending, by adjusting each point of the bending parts to acquire straight bends. The need for shimming is eliminated.

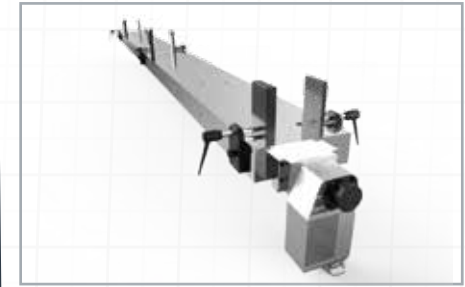

CNC Crowning System

### ■ Linear Guide Front Sheet Supports

Rugged support arms with tilting stops are mounted on a linear guide rail system. This allows 'finger-tip' lateral adjustment as required by the bend length of the part. They are also equipped with side gauges for the fast, easy and accurate feeding of small or large parts.



Linear Guide Front Sheet Supports

### ■ CE Safety Systems

Our machines are designed in accordance with CE-Norms to ensure your safety with hydraulic, electric, appropriate height covers and laser light curtains. CE safety in tandem machines are also provided with light barriers.



CE Laser Safety System

### ■ Stable Top Beam Movement

By using long and planar guiding surfaces, all the disadvantages of point guiding are eliminated 100% free bending space: Guiding system that eliminates bending between frame has been moved to the outside of the frame.

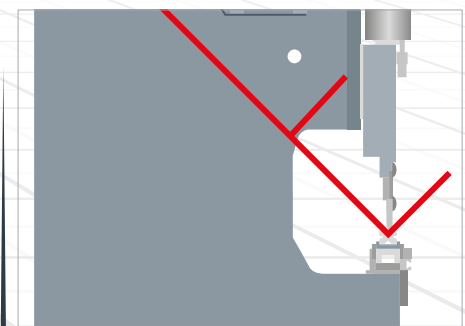

90 Degree Endless Bend

DURMA Touch

## DT10 Control Unit



Everything is Under Control  
With User-Friendly Interface...



Create profile with touch screen



Online service via internet connection



Diagnostic mode



Easy programming page



Automatic bend calculation and listing



Tool programming and library

- Automatic bend listing
- Archiving your bendings
- Easy bend functioning
- 2D color graphics display and multiple simulation
- Linux operating system
- D-Bend offline software
- Tandem compatible
- Multiple language options
- Ergonomic panel design
- USB port, back-up 10" TFT color touch screen

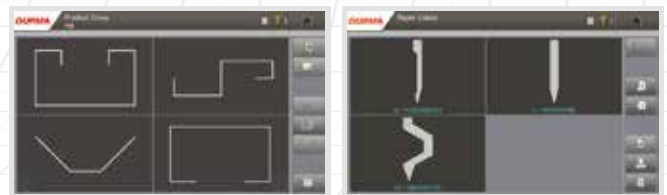

### All the solutions are a click away with the DT10

#### Alarm Help Screen

Alarm help screen is finding a solution for the operator step by step. This module makes the operator's life easier with rapid solutions.

### D-Bend offline software

D-Bend Offline software allows you to simulate your bendings at your desk in your office. You can create your tools. It provides the opportunity to make new programs without interrupting production. In addition to the errors that occur when you start your process yet you will find the opportunity to pre-intervention. D-Bend verifies your unfoldment. Creates verified part drawings for laser, punch, and plasma machines.

Production is *More Effective Now.*

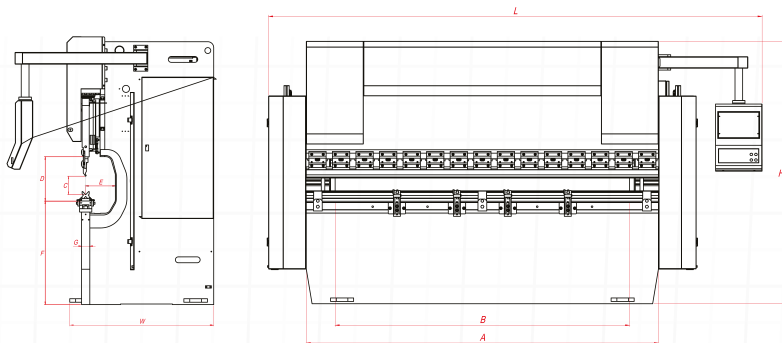

## PBF Series Technical Details

			PBF 1030	PBF 2560	PBF 30120	PBF 30200	PBF 40160
Bending Force	Ton		30	60	120	200	160
Bending Length	mm	A	1050	2550	3050	3050	4050
Distance Between Columns	mm	B	850	2150	2550	2550	3600
Stroke	mm	C	160	160	180	210	200
Daylight	mm	D	390	350	375	445	430
Throat Depth	mm	E	250	250	250	250	300
Y Axes Rapid Speed	mm/sec		200	120	100	100	160
Y Axes Working Speed	mm/sec		10	9	9	7	10
Y Axes Return Speed	mm/sec		130	70	77	73	140
Table Height	mm	F	835	813	878	858	858
Table Width	mm	G	104	104	104	104	104
X Axes Working Speed	mm/sec		250	250	250	250	250
X Axes Travel	mm		400	620	620	620	620
Motor Power	kW		5.5	5,5	11	15	15
Length	mm	L	2470	3250	3750	3750	4850
Width	mm	W	1250	1200	1230	1390	1900
Height	mm	H	2245	2350	2400	2500	2610
Weight Approx.	kg		3250	4250	5900	8160	10500

## STANDARD & OPTIONAL EQUIPMENT

### Standard Equipment

Y1, Y2, X - 3 Axis

F. AKAS FPBS Safety system without CE

Manuel crowning (Include PBF 30120, PBF 30200, PBF 40160)

Control Unit - DT 10 Touch screen 2D graphic (Remote Control)

X=500 Back gauge system with: motorized & linear guide & ballscrew

European clamping system

European clamping system top tool

European style bottom tool holder

Support arms with T-Slot

Safety side covers (Non CE)

World known electrical equipment

### Optional Equipment

Control Unit DT 15

Manual F.AKAS II M FPSC-B-C (Safety PLC) with CE

Motorised crowning system (available for PBF 2560 - 30120 - 30200 - 40160)

D-Bend offline software (3D importer)

Bottom tool DURMA Multi V

European style bottom tool

Quick release clamping

Additional finger blocks

Additional support arms with T-Slot

Oil coolant / oil heater

Overseas special packing

Manuel crowing system (Just for PBF 2560)



Production is *More Effective Now.*

# FAST ON SERVICE AND SPARE PARTS





DURMA provides the best level of service and spare parts with qualified personnel and spare parts in stock. Our experienced and professional service personnel are always ready at your service. Our professional training and application enriched courses will give you an advantage to use our machinery.

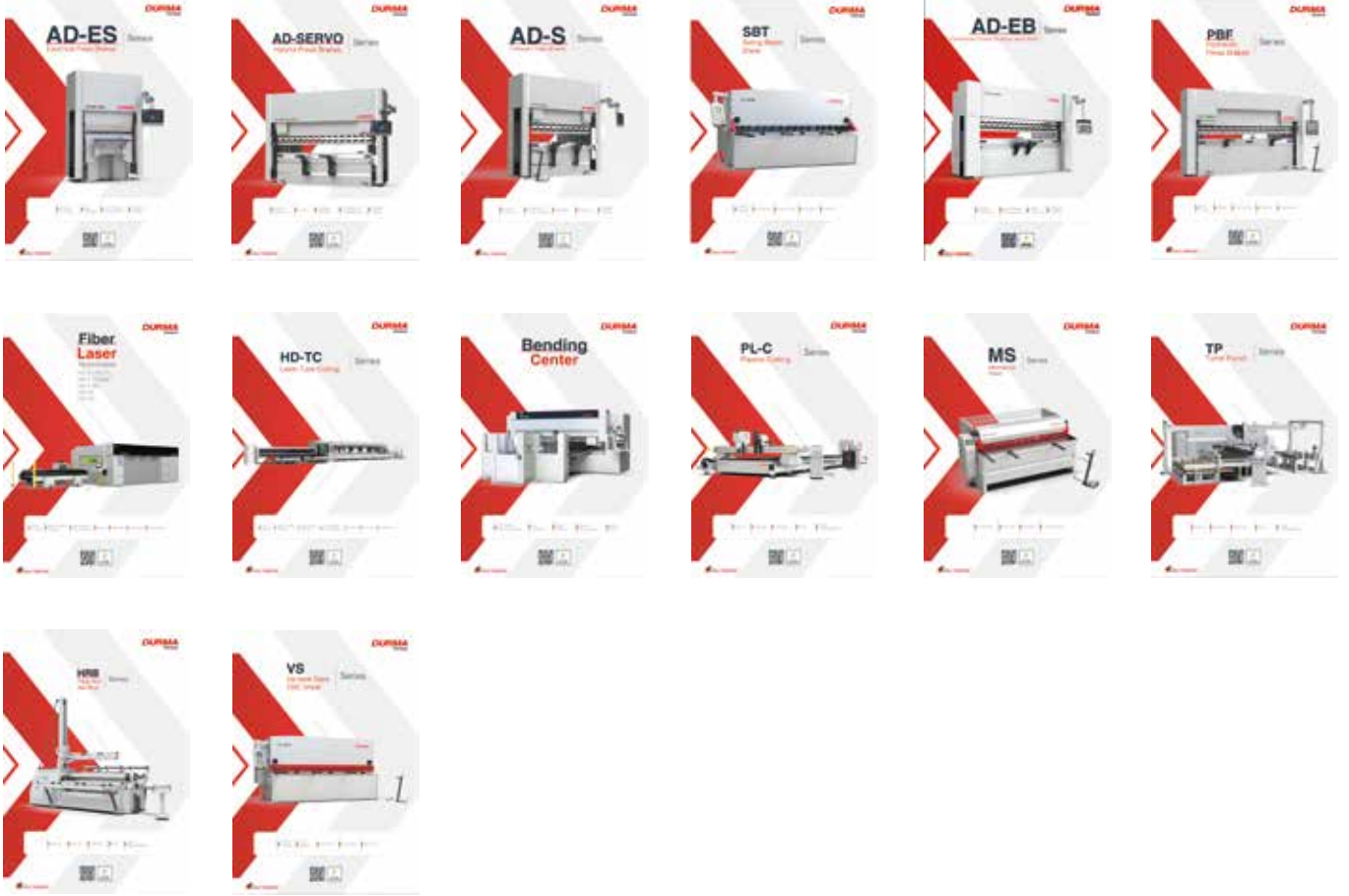

# Product Groups

# DURMA



-  Durma International
-  durmainternational
-  durmaint
-  durmamachines
-  Durmazlar



EN 2024/08/V03



Durmazlar Makina San. ve Tic. A.Ş.  
OSB 75. Yıl Bulvarı Nilüfer-Bursa /  
Türkiye  
P: +90 224 219 18 00  
F: +90 224 242 75 80  
info@durmazlar.com.tr

www.durmazlar.com.tr

Durmazlar Makina San. Tic. A.Ş. has right to change catalogue values and machine technical details without notice.