

# PL-C

Plasma Cutting

Series



Strong

Precise

Efficient

Fast

High  
Repeatability



As a total supplier for sheet metal manufacturing with almost 70 years of experience, Durma understands and recognizes the challenges, requirements and expectations of the industry. We strive to satisfy the ever higher demands of our customers by continuously improving our products and processes while researching and implementing the latest technologies

In our three production plants with a total of 150.000 m<sup>2</sup>, we dedicate 1,000 employees to delivering high quality manufacturing solutions at the best performance-to-price ratio in the market.



**PRODUCTION IS**  
**MORE EFFECTIVE** NOW



From the innovations developed at our Research & Development Center to the technical support given by our worldwide distributors, we all have one common mission: to be your preferred partner.

**Durmazlar offers it's machines to the world markets under the Durma brand.**



**1**

High technology,  
modern production  
lines



**2**

Top quality  
components

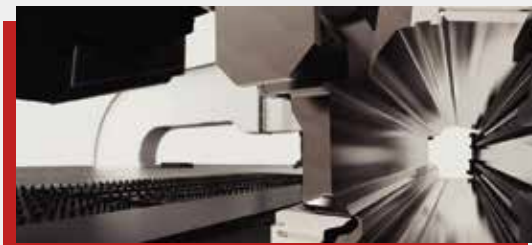

**3**

High quality  
machines designed  
in R&D Centre

# PL-C

## PL-C Plasma Cutting Series

Durma has redefined its plasma cutting technology with PL-C series. The PL-C Series is manufactured as a true precision tool for plasma cutting. These high performance plasma machines are designed to cut a wide range of mild steel, stainless steel and aluminum.

- **Precise Cutting**
- **High Durability**
- **Energy Efficiency**
- **Low energy consumption**

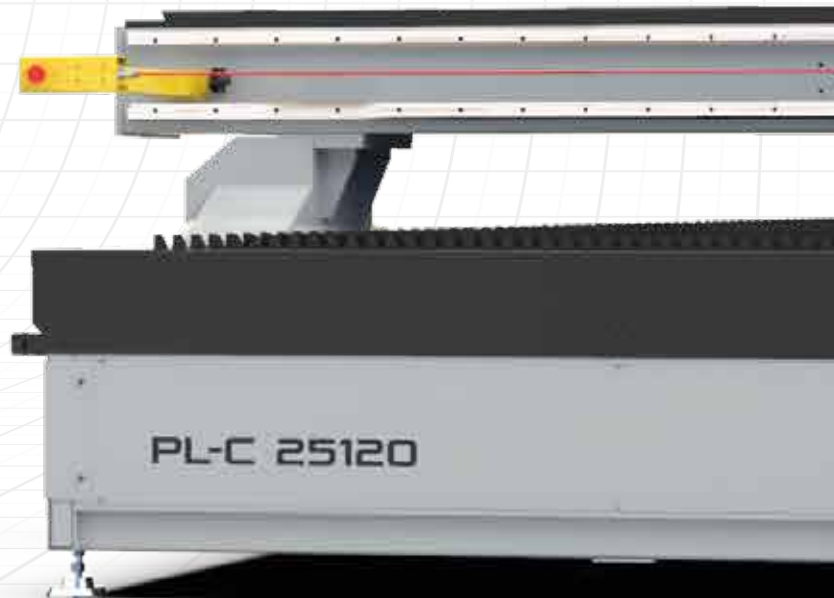



Production is *More Effective Now.*

## Perfectly equipped for precise cuts

### Why DURMA Plasma Cutting Machines

- Better and faster and more precise cuts
- Rigid body structure
- Long Durability
- Hi-tech equipment
- AURORA Plasma Software
- Reliable brand



## A PLASMA THAT YOU CAN COUNT ON

### “Reliability and Durability” that what makes a DURMA plasma

PLC Plasma cutting machines are reliable source of plasma cuttings when it comes to higher level of material thickness. Hyperterm cutting head and AURORA plasma software ensure precise and quality cuts. AURORA enables users to enhance plasma with extensive specifications and capabilities. Depending on material and thickness, cut quality and cutting speed we can offer you the appropriate solutions for your tasks.

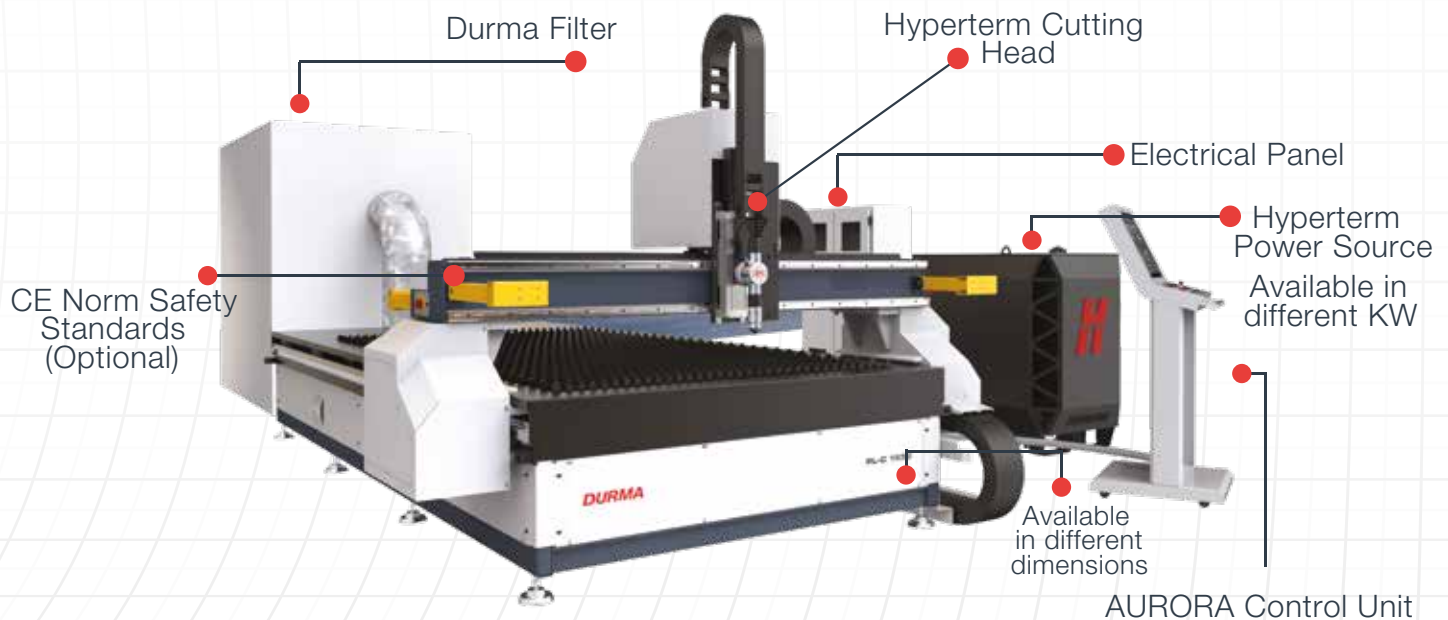

### General Specifications

- Sensitive, precise Hyperterm cutting head
- DURMA designed and copyrighted AURORA control unit
- Hypertherm power supply options for different sheet thicknesses
- Rigid body structure with long durability and high performance
- Electrical Panel and Durma Filter that creates safer working environment
- Sensitive solutions at high material thickness
- Variety of dimension models can be made according to the size of material to be cut
- CE Norm Safety Standarts (Wire)
- Environment friendly, enery efficient and eye-pleasing AURORA software

## PLC SERIES STANDARD EQUIPMENT

### ■ Steel Construction

Strengthened steel body structure increases DURMA plasma's durability and performance.



### ■ Hypertherm Cutting Head

Hypertherm cutting head is designed for fast cutting speeds, long life and superior cut quality for high productivity and low operating costs. Hypertherm delivers superior HyPerformance cutting across a broad range of application needs, from very thin to heavier thickness.



### ■ Durma CNC Control Unit

PLC series come with standard DURMA CNC control unit that provides convenient user experience. Users can realize tasks on plasma efficiently with a user-friendly control unit.



### ■ Hypertherm Power Source

Hypertherm combines fast cutting speeds, rapid process cycling, quick changeovers and high reliability to maximize productivity. Key advantages are new HDi thin stainless steel technology, superior cut quality and consistency, maximized productivity, minimized operating cost and unmatched reliability.



CNC Crowning System



Linear Guide Front Sheet Supports



CE Laser Safety System



90 Degree Endless Bend



# PL-C

## PLC SERIES OPTIONAL EQUIPMENT

### ■ Bevel Cutting

Precision and accuracy are two important elements that define Durma Bevel cutting device. It allows users to cut up to 45 degrees angle and automatically controls torch height to prevent distributions and collisions.

Depending on power source, Bevel cut can handle up to 40 mm of material thickness.



### ■ Drilling Head

Drilling head is an optional feature that is designed for variety of drilling types. It can include up to six drilling head that can drill the plate according to program set on the software.



### ■ DURMA Filter Unit

Drilling head is an optional feature that is designed for variety of drilling types. It can include up to six drilling head that can drill the plate according to program set on the software.



### ■ Pipe Cutting

Different industrial applications can be performed with PLC series. In this matter, PLC series answer to your pipe cutting needs perfectly. Increased productivity and accuracy can be achieved with pipe cutting option on PLC series.



Production is *More Effective Now.*

# AURORA Plasma Cutting Software

“One single software to consolidate all of your needs...”

Let us introduce our latest development on plasma cutting technologies:

**DURMA** has realized **AURORA** that will answer to your cutting needs. Durma ensures convenience for its user with AURORA that consolidates all of your cutting needs with a single software.

Durma named this software AURORA because it has a eye-pleasing interface and it is very user-friendly. Aurora is applicable to variety of industrial applications such as **plasma cutting, oxi cutting, bevel cutting, pipe cutting, drilling, tapping** and most importantly **true hole technology**.

We burst with pride of AURORA and we would like it to be heard by everyone. That is why it features multi-language and manual translation mode to address its users on a global scale.

AURORA is set as standard software on all DURMA plasma cutting machines and ready to operate on a 24/7 basis.



Fast Data Entry    Task Management    Increased Efficiency



- Complete Service
- Increased Productivity
- User-friendly Interface
- Remote Service Mode
- Flexible Operation Ability



## **HYPERTHERM Plasma Power Source**

**“Perfect equipment for perfect results...”**

The XPR300™M represents the most significant advance in mechanized plasma cutting technology, ever. This next generation system redefines what plasma can do by expanding its capabilities and opportunities in ways never before possible. With unmatched X-Definition® cut quality on mild steel, stainless steel and aluminum, the new XPR300 increases cut speed, dramatically improves productivity and slashes operating costs. New ease-of-use features and engineered system optimization make the XPR300 easier to run with minimal operator intervention, while also ensuring optimal performance and unmatched reliability.

### **Key Advantages**

- HDi Thin Stainless Steel Technology
- Low Operating Costs
- Precise and Quality Cuts
- Unmatched Reliability
- HyDefinition Technology





## True Hole Technology

Hypertherm's patent-pending True Hole cutting technology for mild steel produces significantly better hole quality than what has been previously possible using plasma. This is delivered automatically without operator intervention, to produce unmatched hole quality that surpasses the competition.



■ With True Hole technology cut with XPR Plasma

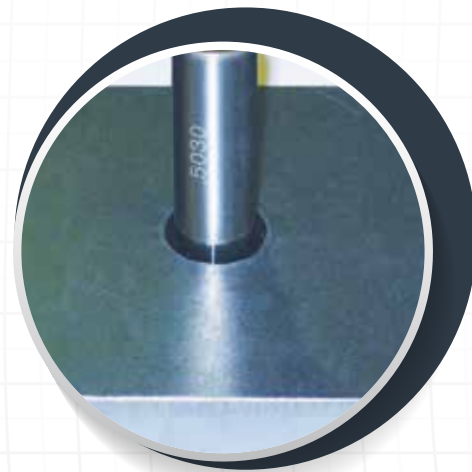

■ Without True Hole technology cut with XPR Plasma

### Cross section of a hole

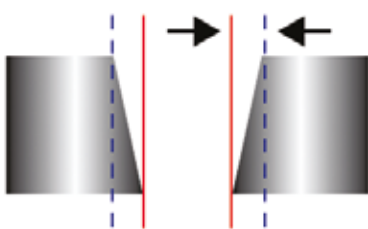

**Cylindricity is a measure of hole quality**

Hypertherm's True Hole cutting technology for mild steel is exclusively available for use on Hypertherm's XPR auto gas plasma systems and is automatically applied by our cutting optimization and nesting software and CNC software to holes up to 1" with hole diameter to thickness ratios as low as 1:1.

True Hole technology is a specific combination of the following parameters that is linked to a given amperage, material type, material thickness and hole size:

- Process gas type
- Gas flow
- Amperage
- Piercing methodology
- Lead in/out technique
- Cut speed
- Timing

True Hole Technology requires a HyPerformance Plasma XPR auto gas system along with a True Hole enabled cutting table, nesting software, CNC, and torch height control.

## HYPERTHERM XPR 170 / 300

- Unmatched performance. Unbeatable operating cost.
- Industry leading X-Definition cut quality
- Optimized productivity and reduced operating costs
- Expanded HyDefinition technology
- Vented Water Injection (VWI)
- Improved torch geometry

The XPR advances HyDefinition® cut quality by blending new technology with refined processes for next generation, X-Definition cutting on mild steel, stainless steel and aluminum.



- Consistent ISO range 2 results on thin mild steel
- Extended ISO range 3 cut quality results compared with earlier plasma technology
- Superior stainless steel cut quality across all thickness ranges
- Superior results on aluminum using Vented Water Injection™ (VWI)

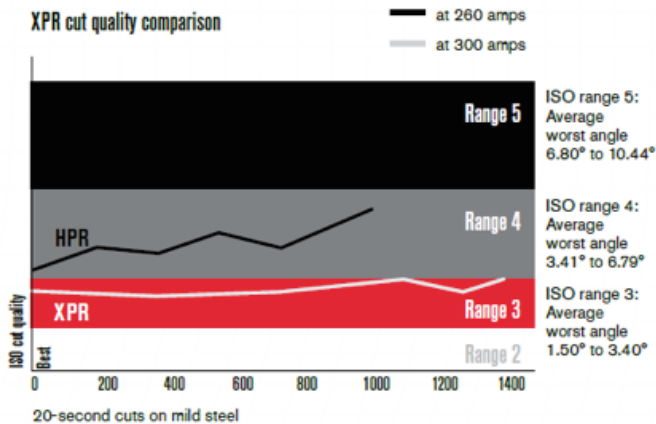

### ■ Core™ console

Unmatched mild steel cutting performance and superior angularity and edge finish on stainless steel up to 12 mm (1/2"). This is delivered through a new N2 HDi™ process that prevents the mixing of air into the plasma gas, creating an improved, brighter edge finish.

### ■ OptiMix™ console

All the capabilities of the Core and VWI consoles plus discrete 3-gas mixing – Ar, H2, and N2 – for the world's most flexible, premium stainless steel and aluminum cutting capability.



■ **OXY Cut**

Durma CNC controlled cutting oxygen provides 120 mm cutting opportunity. There is 45-degree angle cutting manual option in A axis and B axis. In terms of special applications, cutting thickness of 200 mm can be done easily.

■ **Air Dryer**

It dries the moisture in the air in the environment and enables it to be used in the machine. Dry air is a requirement to ensure the long-term operation of system equipment, especially in the case of plasma cutting.

■ **Longer Consumable Life**

With long-life technology patent, we provide long consumable life for materials by using the world class equipments and control systems. The wide range of cutting options with the high cutting speeds on same materials are applied. High performance materials are designed to provide quality cuts with lower costs.



**Machine may not look as it appears**



# PL-C

## ■ CNC Control Unit

Durmazlar uses own plasma software called Aurora on Beckhoff CP 2919 control units. Users can load cutting parameters easily. Also users can call preloaded simple shapes from the library and can add more new shapes to the library. The cutting process can be seen on the screen during cutting.

The Control Panel can be connected to another computer or LAN by Ethernet Connection Point.

The machine automatically searches the plate, machine finds the zero point and calculates the angle automatically.



## ■ CAD Cam Software

Metalix/Lantek software is available for easy programming and drawing of parts. It also easily and quickly converts DXF and DWG files to machine language for cutting.

The automatic nesting feature looks at the multiple parts to be cut from the sheet, and then organizes them on the sheet in the most efficient way. Lower material costs.

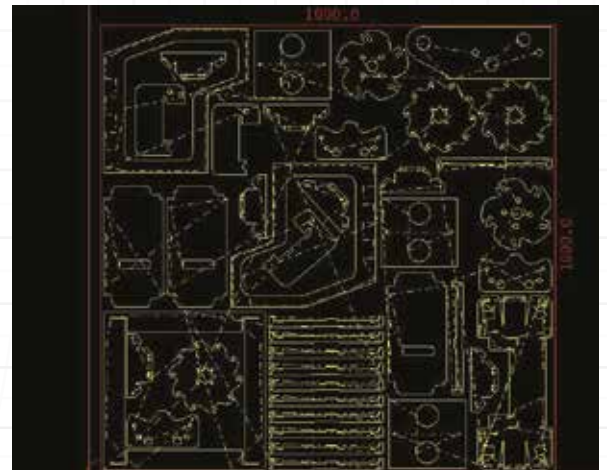

## ■ Torch Height Control

Durma Torch Height Control System is designed for Plasma Cutting Machines such as cutting process on X-Y tables. System sets cutting height automatically between Torch and Working Part by using ark voltage.

Breakaway System protects the Torch via stopping the system if there is any error on system occurs crashes.



# Fume Extraction System

It is designed for filtration of released smoke and dust in the plasma cutting applications

Panel filters produced with non-woven polyester and covered with PTFE membrane. Panel filters 0.2-2 micron range particles are capable of filtering efficiency of 99.9%. It filtrates; According to DIN EN 60335 standard it is Class: M and According to DIN EN 1822 standard it is Class: H13. Average filter life is 20,000 operating hours. There is dust bucket. Easy Strippers are fully sealed wheel-mounted.

Dust bucket volume is 80 lt.

Low noise level with advanced silencer structure <70dB(A)

All connection pipes between Plasma Machine and Filter galvanized. Galvanised pipes minimizes losses.

Type	Capacity (m <sup>3</sup> /h)	Motor (kW)	Fan Pressure (Pa)	Filter Surface (m <sup>2</sup> )	Filter Number	A (mm)	B (mm)	H (mm)	ØD (mm)	X (mm)	Y (mm)	Weight (kg)
PL-6000	6000	7,5	2950	95	10	2384	1514	2190	350	901	1419	795
PL-8000	8000	7,5	2300	133	14	3004	1514	2190	400	901	1419	925
PL-10000	10000	11	2600	152	16	3382	1514	2190	450	901	1419	1160

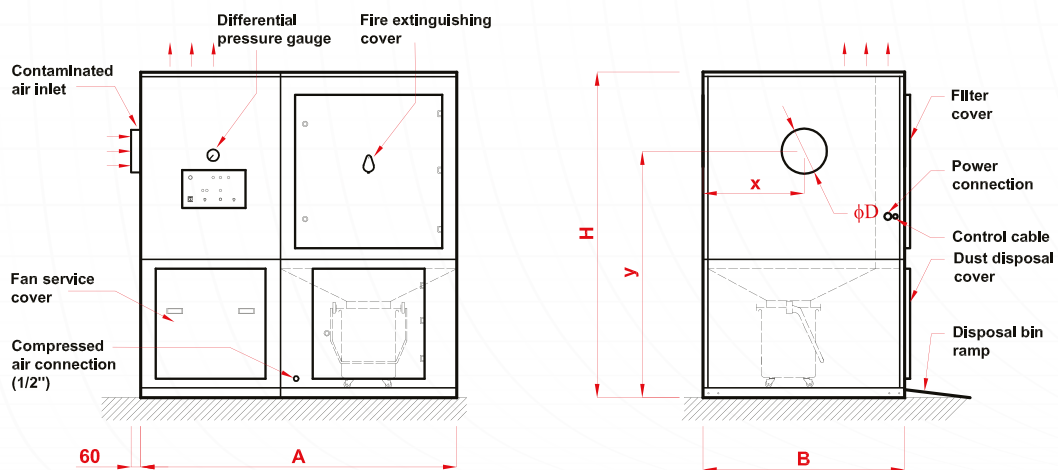

- Long life cartridge
- Easy filter maintenance



# PL-C



## ■ Multi Drilling Head

Durma multi drilling systems are designed as mass production-oriented. The existence of 4 and 6 options is available and HSK-63 series are used with tool holders which have high precision.



## ■ Bevelling Head

Durma 5-axis Plasma Angled Cutting Unit special designed for respond to multiple angled cuttings.

Durma 5-axis Cutting can be done by providing a 45 degrees angle by angle cutting unit and quickly switch between different angles it allows you to smooth contours.



## ■ Single Drilling Head

Durma single drilling systems are designed with a compact structure. M16 tapping; it has the capacity of drilling up to  $\text{Ø}20$



## Pipe Cutting

Durma pipe-profile cutting unit has been specially designed to cut the tubes and profiles of different sizes.

Max Speed	mmpm	2500
Minimum Pipe Diameter	mm	Ø50
Maximum Pipe Diameter	mm	Ø400
Maximum Profile Size	mm	250x250
Maximum Pipe-Profile Length	mm	6000 mm
Maximum Pipe-Profile Weight	kg	1150 kg
Mirror Mechanism: 4 Clamp, Manual Crimping		

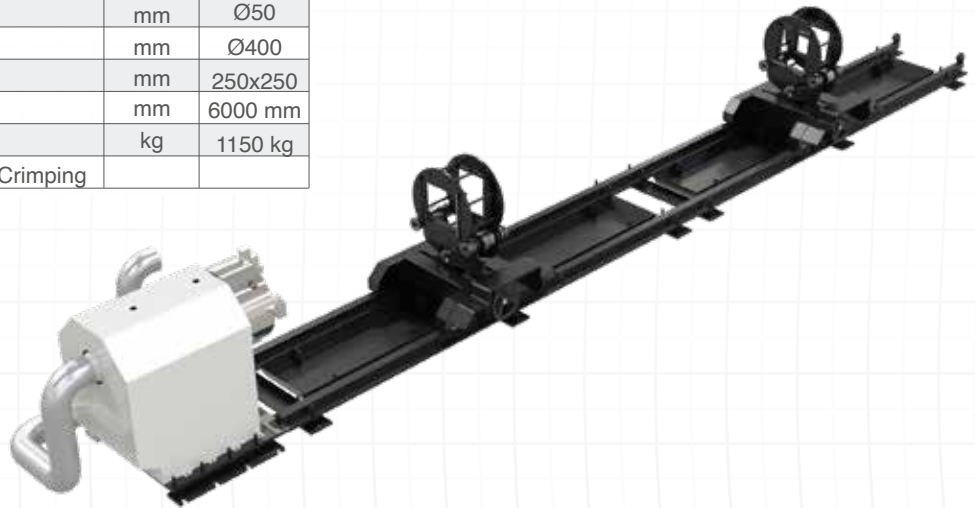

## Cutting Tables

Patented Durma modular tables contains on a lot of advantages, such as high-precision cutting quality and easy installation.

Durma plazma cutting machine tables are with high engineering design devided, section by section in a horizontal and vertical way to achive the maximum efficiency of the filter.

Cover on the cut section are controlled by pneumatic valves.

- Easy Installation
- High Sensitivity
- Easy Cleaning



## Power Source Specifications

POWER SOURCE SPECIFICATIONS	Unit	Hypertherm XPR 170	Hypertherm XPR 300
Gas Console	-	Core/VWI/Optimix	Core/VWI/Optimix
Max. High Quality Cutting Capacity (MS) (Edge Start)	mm	60	80
Max. High Quality Cutting Capacity (MS) (Pierce Capacity)	mm	40	50
		35	45
Max. Positioning Speed X / Y	mm	35000	35000
Positioning Accuracy	mm	+/-0.1	+/-0.1
Repeatability	mm	0.01	0.01
Output Current	A	170	300
Current Regulation Range	A	30 - 170	30 - 300
Cutting Angle (ISO9013:2000 Category range)	-	2 - 4	2 - 4
Plasma Gas	-	O <sub>2</sub> , N <sub>2</sub> , H35.F5 Air	N <sub>2</sub> , F5, Ar, H35, O <sub>2</sub> , Air
Plasma Shield Gas	-	O <sub>2</sub> , N <sub>2</sub> , Air, H35	O <sub>2</sub> , N <sub>2</sub> , Air, H35

Production is *More Effective Now.*

## Power Source Specifications

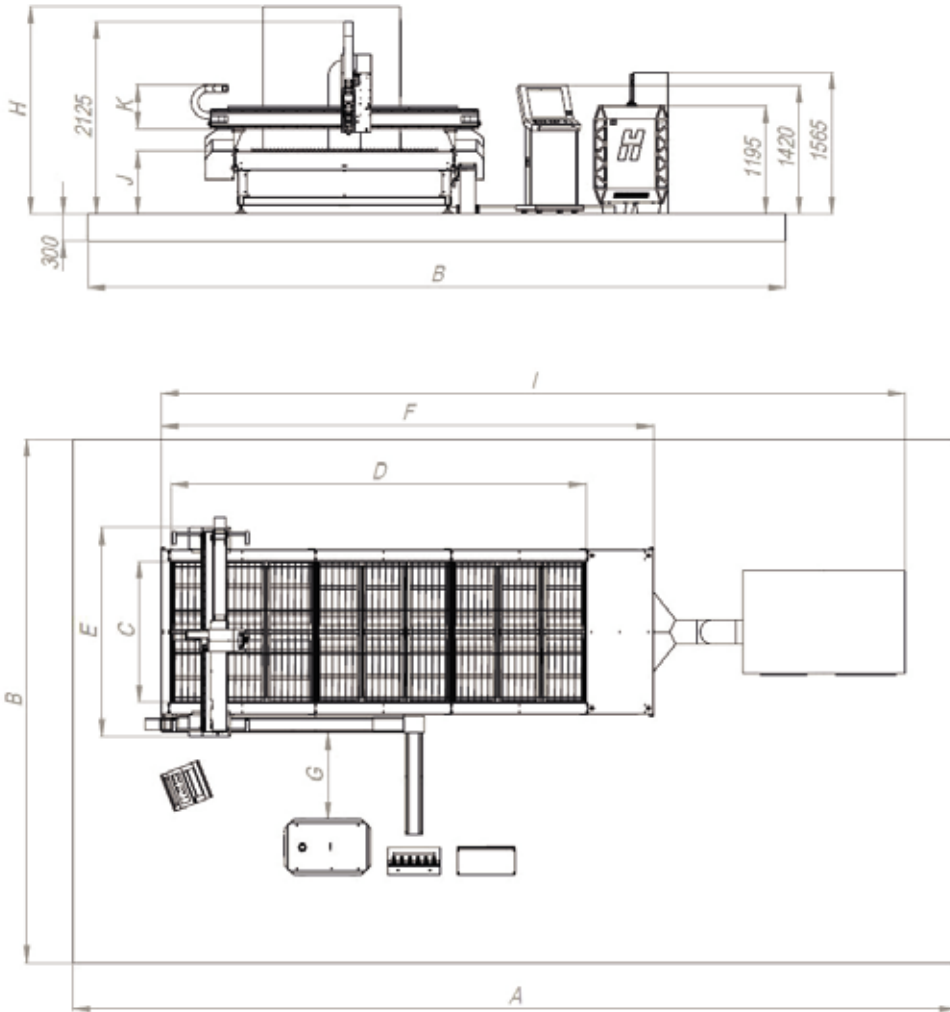

Machine Type	Machine Installation Length	Machine Installation Width	Part Cutting Area Width	Part Cutting Area Length	Machine Width	Machine Length	Distance Between Machine and Power Supply	Filter Height	Machine Length with Filter	Table Height	Z-axis Stroke	Weight (Without Filter)
	A	B	C	D	E	F	G	H	I	J	K	
PL-C 2060	13000	7700	2080	6100	3000	7240	1500	2200	12424	700	220	6000 Kg
PL-C 20120	19500	7700	2080	12100	3000	13240	1500	2200	19044	700	220	11500 Kg
PL-C 30120	19700	8700	3080	12100	4000	13240	1500	2200	19422	700	220	15000 Kg

## STANDARD & OPTIONAL EQUIPMENT

### Standard Equipment

Welded Steel Construction

DURMA CNC Control Unit (AURORA)

Remote Control Diagnostic (Ethernet)

Lantek/Metalix Software W/Autonesting

Cutting Plate Alignment by Laser

DURMA Torch Height Control

Two Side Motion Control System (Rack & Pinion)

AC Servomotors for X & Y axes motion

CNC control outputs/inputs for filter unit

Consumables starting kit

Plasma torch\*

Torch connect console\*

\*If Power source is selected

### Optional Equipment

Hypertherm XPR 300

Core Gas Console for Hypertherm XPR 170 / 300

VWI Gas Console for Hypertherm XPR 170 / 300

Optimix Gas Console for Hypertherm XPR 170 / 300

CE Norm Safety Wire

Oxy-fuel Torch

Plasma Torch Brake System

Man. Plasma Beveling Head (+/- 45)

Cnc. Plasma Beveling Head (+/- 45)

Single Drilling Head

4 - 6 Drilling Heads

Filter for 170 A

Filter for 300 A

Filter for 400 A

Air Dryer

Tube Cutting Device Ø50 mm - Ø400 mm

Additional Support for Tube cutting device

Fault and Program end signal lamp

Pendant Control



Production is *More Effective Now.*

# FAST ON SERVICE AND SPARE PARTS





DURMA provides the best level of service and spare parts with qualified personnel and spare parts in stock. Our experienced and professional service personnel are always ready at your service. Our professional training and application enriched courses will give you an advantage to use our machinery.

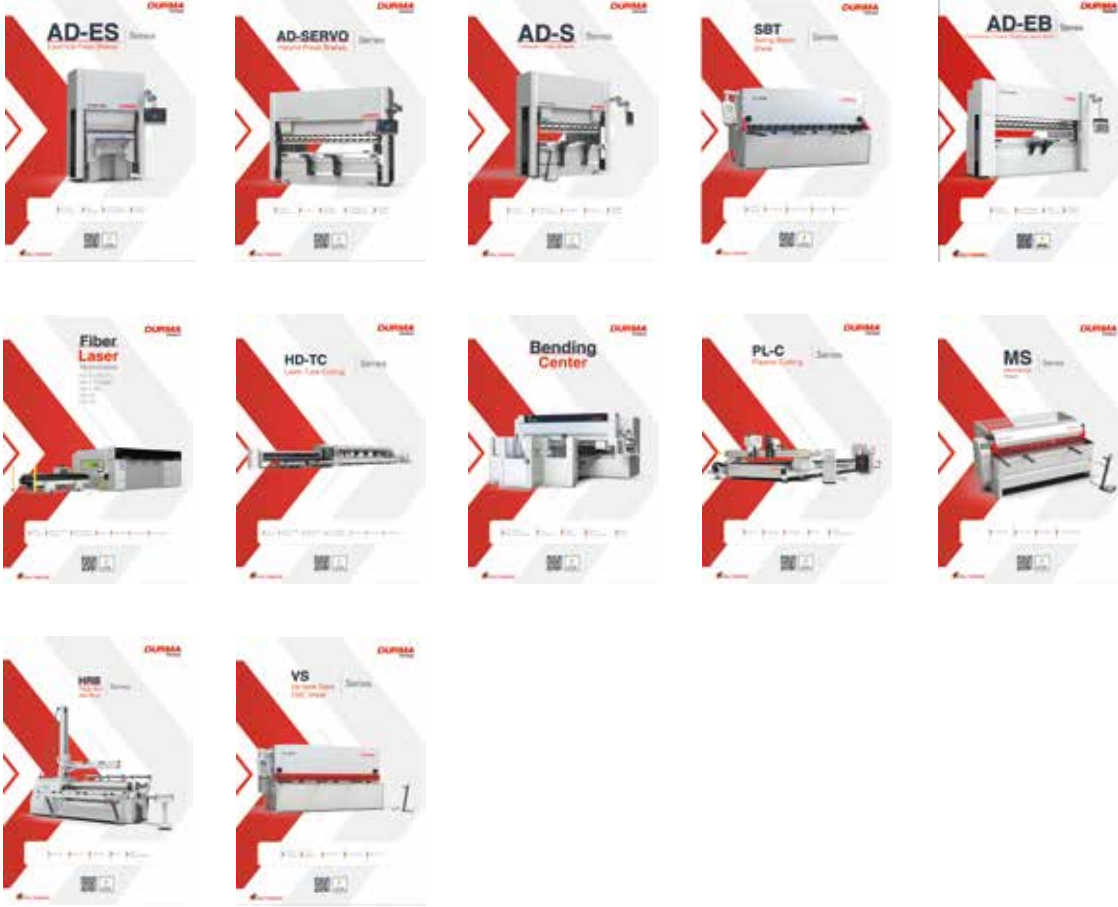

# Product Groups

# DURMA



-  Durma International
-  durmainternational
-  durmaint
-  durmamachines
-  Durmazlar



EN 2024/08/V03



Durmazlar Makina San. ve Tic. A.Ş.  
OSB 75. Yıl Bulvarı Nilüfer-Bursa /  
Türkiye  
P: +90 224 219 18 00  
F: +90 224 242 75 80  
info@durmazlar.com.tr

www.durmazlar.com.tr

Durmazlar Makina San. Tic. A.Ş. has right to change catalogue values and machine technical details without notice.