

**VS**

Variable Rake  
CNC Shear

Series



Perfect  
Cutting

Fast  
Speed

Powerful

Accurate

Efficient



Low Power  
Consumption

As a total supplier for sheet metal manufacturing with almost 70 years of experience, Durma understands and recognizes the challenges, requirements and expectations of the industry. We strive to satisfy the ever higher demands of our customers by continuously improving our products and processes while researching and implementing the latest technologies

In our three production plants with a total of 150.000 m<sup>2</sup>, we dedicate 1,000 employees to delivering high quality manufacturing solutions at the best performance-to-price ratio in the market.



**PRODUCTION IS**  
**MORE EFFECTIVE** NOW

From the innovations developed at our Research & Development Center to the technical support given by our worldwide distributors, we all have one common mission: to be your preferred partner.

**Durmazlar offers it's machines to the world markets under the Durma brand.**



**1**

High technology,  
modern production  
lines



**2**

Top quality  
components

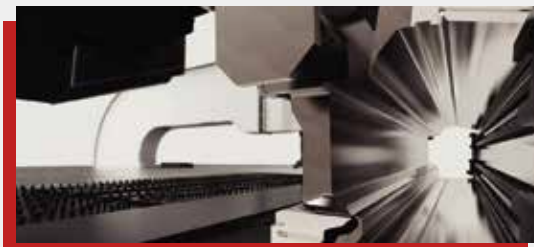

**3**

High quality  
machines designed  
in R&D Centre

# VS

## VS Series

### Variable Rake CNC Shear

Well equipped for precision cuttings ( $\pm 0.05$  cutting precision)

High technology VS variable rake shears, with  $0^{\circ} 30'$  -  $2^{\circ} 30'$  precise rake adjustment, cut fast and efficiently. Easy to use and good quality cutting feature are suitable for every job. By entering all cutting parameters you can have precise and perfect cutting.

High efficient and maximum security VS shears will differentiate you with its precise cutting.

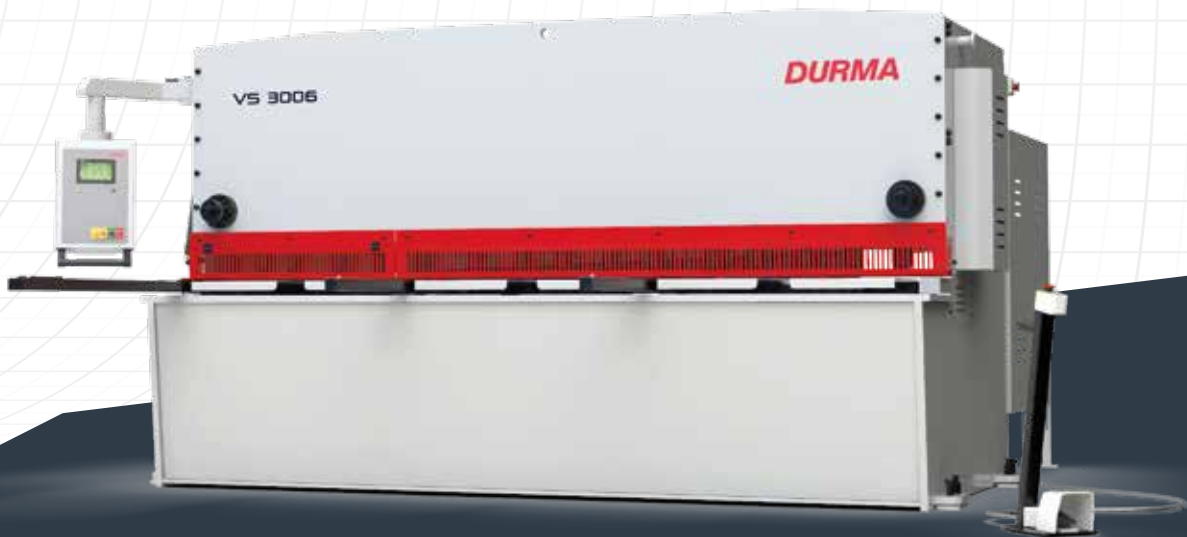

Production is *More Effective Now.*

# Advance Your Standards

## Precision and high quality cuts with automatic gap adjustment

In world standards equipped with high-tech products VS Series Shears offer you exact solutions. We have reduced the cutting angle to achieve straight precision and minimum twist tolerance.



## Why DURMA Shears

- Better and faster cuttings
- Automatic blade gap adjustment
- Stronger and rigid body structure
- High sensitivity and repeatability
- High-tech excellent equipments
- Low service cost
- Adds value to your company
- Reliable brand

We have minimized the cutting angle to provide sensitivity to minimum linearity and torsional tolerance in the total material length.

# VS

## GAIN MORE POWER

### Performance and Productivity

The DURMA VS series CNC variable rake shear is one of the most advanced production shears available today. From 6 up to 25 mm shearing capability these highly developed machines yield the most flexibility you can hope to get in a modern shearing machine.



### General Specifications

- Robust design & powerful body for perfect cutting
- Hardened and ground blades for long life and precise
- CE standards security
- The combination of economic and perfect cutting performance
- Blade clearance and cutting angle automatically adjusted by CNC controller
- User friendly CNC touch screen control unit
- VS shears provide flexible use for narrow or wide, thin or thick sheet metal cutting.
- Automatic swing up back gauge for more comfortable use
- Sheet support arms
- Front feeding and conveyor systems
- Front support arms T-Slots for easy cutting and feeding material
- Ball Transfer table

Production is *More Effective Now.*

## Special Projects

■ CNC Front Feeding

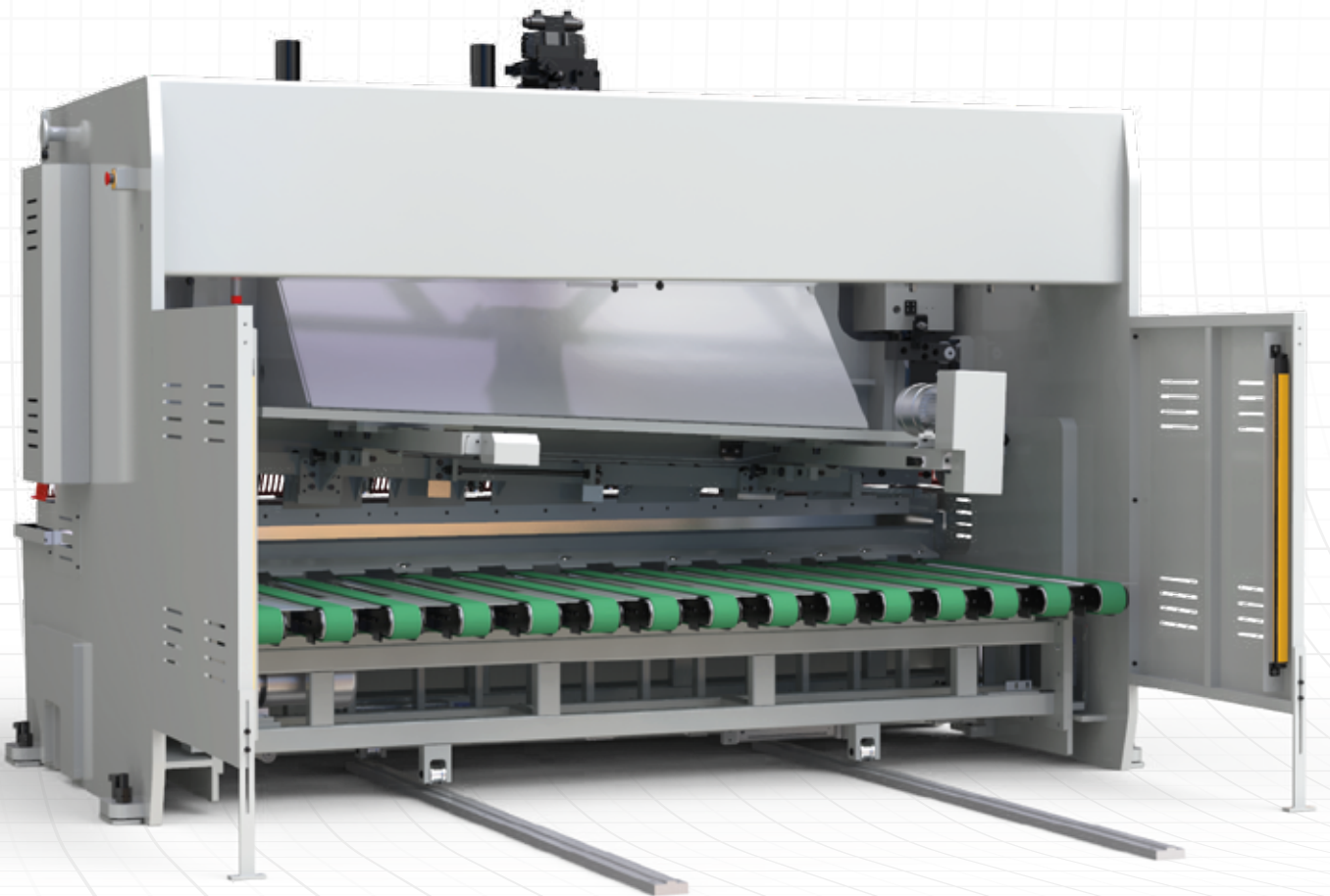

# VS

## D-Touch 7 Control Unit



Fast data entry



Easy connection USB port



Ethernet RJ-45 10/100M



Easy programming

### Cuttings are easier with D-Touch 7

With easy to use interface D-Touch 7 enables perfect cutting in seconds by endless programming and material entrance feature.

- Wide, colored, touch-screen (LCD 7" 800x480)
- Quick data entry
- Easy connection
- USB input
- Ethernet: RJ-45 10/100M
- Windows CE Unlimited program and steps
- Unlimited material type





Production is *More Effective Now.*

## VS Series General Features

With choice of standards and optional equipment VS Series add to value your business by offering proper solutions for your needs. With the high-tech features high efficiency, high precision, high performance criteria VS Series have proved that it is user-friendly and the best of in this sector.



- Flip-up Finger Guard  
Ball Transfer Table  
Hydraulic Holddowns



- Special Throat Depth  
Throat depth of at least 350 mm allows the cutting of longer sheets than the knife length



- Light Curtains For Finger Guard

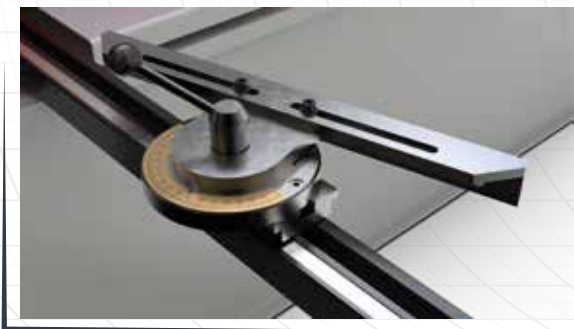

- Adjustable Angle Stop 0-180°

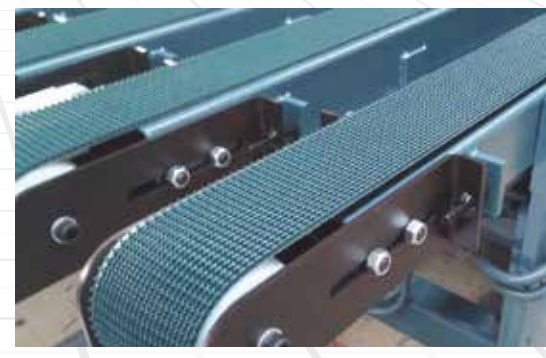

- Conveyor System

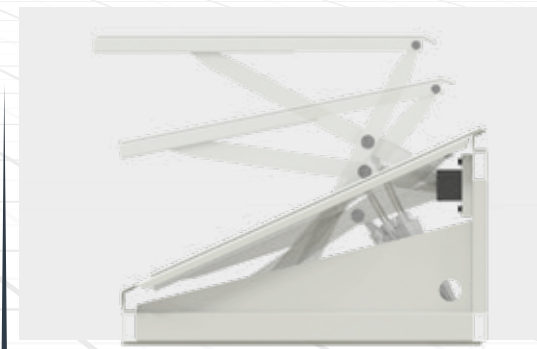

- Thin Sheet Support System

# VS

## STRONG BACK GAUGE SYSTEM

- Precision
- Robust
- Min. Deformation



- Fast and high accuracy
- Reliable movement
- Adjustment at any point
- Resistance to crash
- Maintenance free
- Better and fast cutting
- Easy and secure usage
- High precision and repeatability

### Why DURMA Back Gauge ?

One of the most important factor for cutting capacity is the design of back gauge and stability.

Quality cutting is possible with perfect product, stability and precision back gauge.

The high speed ballscrew back gauge system movement is also supported with linear guides, which helps the back gauge achieve long life, greater sensitivity and strengthens against any collisions.

## Sheet Support Systems

### ■ Pneumatic Thin Sheet Support System

DURMA I

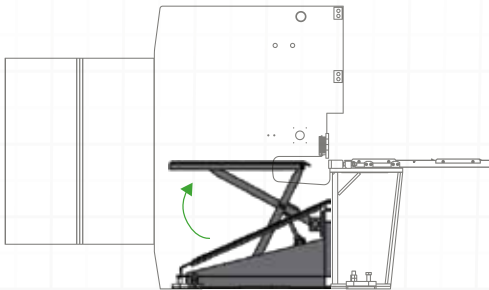

#### Step 1

Before cutting operations, sheet support system with pneumatic driven assists for sheet as moving upwards as per in the picture.

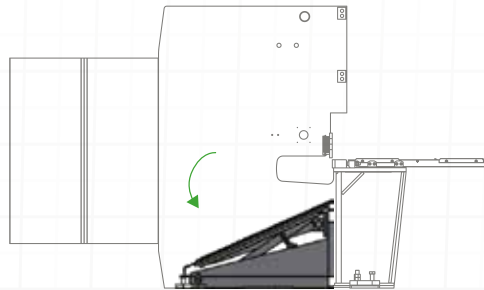

#### Step 2

Once the cutting process is kicked off, the table comes down lower position at the same time and this will ensure cutting sheets placed over the table again as seen in the picture.

### ■ Pneumatic Thin Sheet Support System

DURMA IV

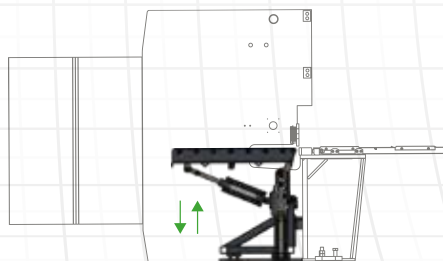

#### Step 1

Before cutting operations, sheet support system with pneumatic driven assists for sheet as moving upwards as per in the picture.

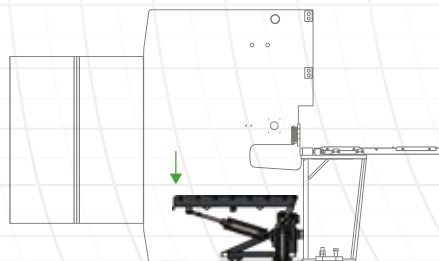

#### Step 2

Once the cutting process is kicked off, the table comes down lower position at the same time and this will ensure cutting sheets placed over the table again as seen in the picture.

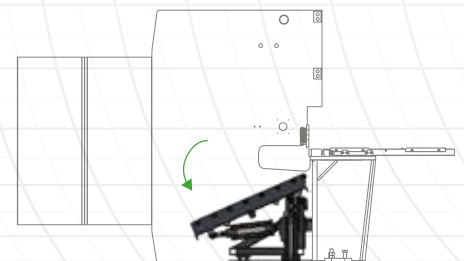

#### Step 3

After cutting process is finished, sheets are discharged by closing movement of the table.

## VS Series Technical Details

VS Series	Cutting Length	Cutting Capacity		Stroke per min.	Cutting Angle		Number of Holddowns	Holddown Force		Back Gauge Range
		MS (450 N/mm <sup>2</sup> )	SS (700 N/mm <sup>2</sup> )	Minimum - Maximum	Minimum	Maximum		Minimum	Maximum	
		mm	mm	1/min.	°	°		Ton	Ton	
	A									
3006	3080	6	4	12 - 20	0° 30'	2°	16	4	20	1000
6006	6080	6	4	6 - 10	0° 30'	2°	29	10	20	1000
6013	6080	13	10	5 - 10	0° 30'	2° 30'	29	29	58	1000

Production is *More Effective Now.*

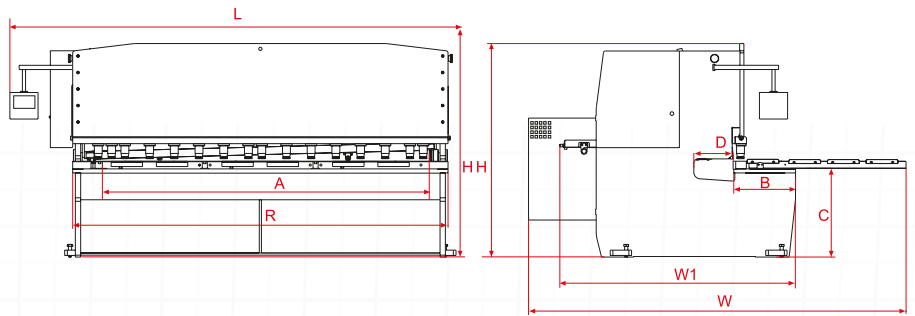

Back Gauge Speed	Motor Power	Oil Capacity	Throat Depth	Front Arms	Table Height	Table Width	Table Length	Length	Width	Total Width	Height	Weight
mm/sec.	kW	lt	mm	Unit	mm	mm	mm	mm	mm	mm	mm	~kg
			D		C	B	R	L	W1	W	H	
200	11	125	350	3	820	494	3280	4100	2050	3650	1950	7980
200	22	200	350	6	900	630	6370	7300	2150	3400	2750	25500
200	37	400	350	6	950	650	6375	7400	2200	3700	2900	33820

Production is *More Effective Now.*

# FAST ON SERVICE AND SPARE PARTS

DURMA provides the best level of service and spare parts with qualified personnel and spare parts in stock. Our experienced and professional service personnel are always ready at your service. Our professional training and application enriched courses will give you an advantage to use our machinery.



# VS

## STANDARD & OPTIONAL EQUIPMENT

### Standard Equipment

- CE-Norm
- Heavy duty steel construction & Stress relieved frame
- User friendly CNC Touchscreen control unit D-Touch 7
- Automatically adjusted rake angle by CNC
- Adjusted cutting length by CNC
- Ball integrated front tables
- Ball screw back gauge, 1000mm
- Flip-up finger guards 1000mm
- Squaring arm with scale T-Slot (L=1500mm)
- Support arms T-Slot & Tilting stop (L=1000mm)
- Illumination & Shadow line
- Throat depth with 350 mm
- Automatically pressure adjusted solid holddowns
- Top and bottom blades with four sides





### Optional Equipment

- Laser Cutting Line
- Light curtains for finger protection
- Pneumatic sheet support DURMA I
- Pneumatic sheet support DURMA IV
- Hydraulic anti-twisting
- Special throat depth
- Back gauge 1250 mm
- X1, X2 axis
- Oil coolant (Standard for VS 6006 & 6013).
- Oil heater (Standard for VS 6006 & 6013)
- Central lubrication manual
- Central lubrication motorized
- Adjustable angle stop 0-180°
- Add. Support arms
- Special blades
- Temperature measurement
- Overseas special packaging

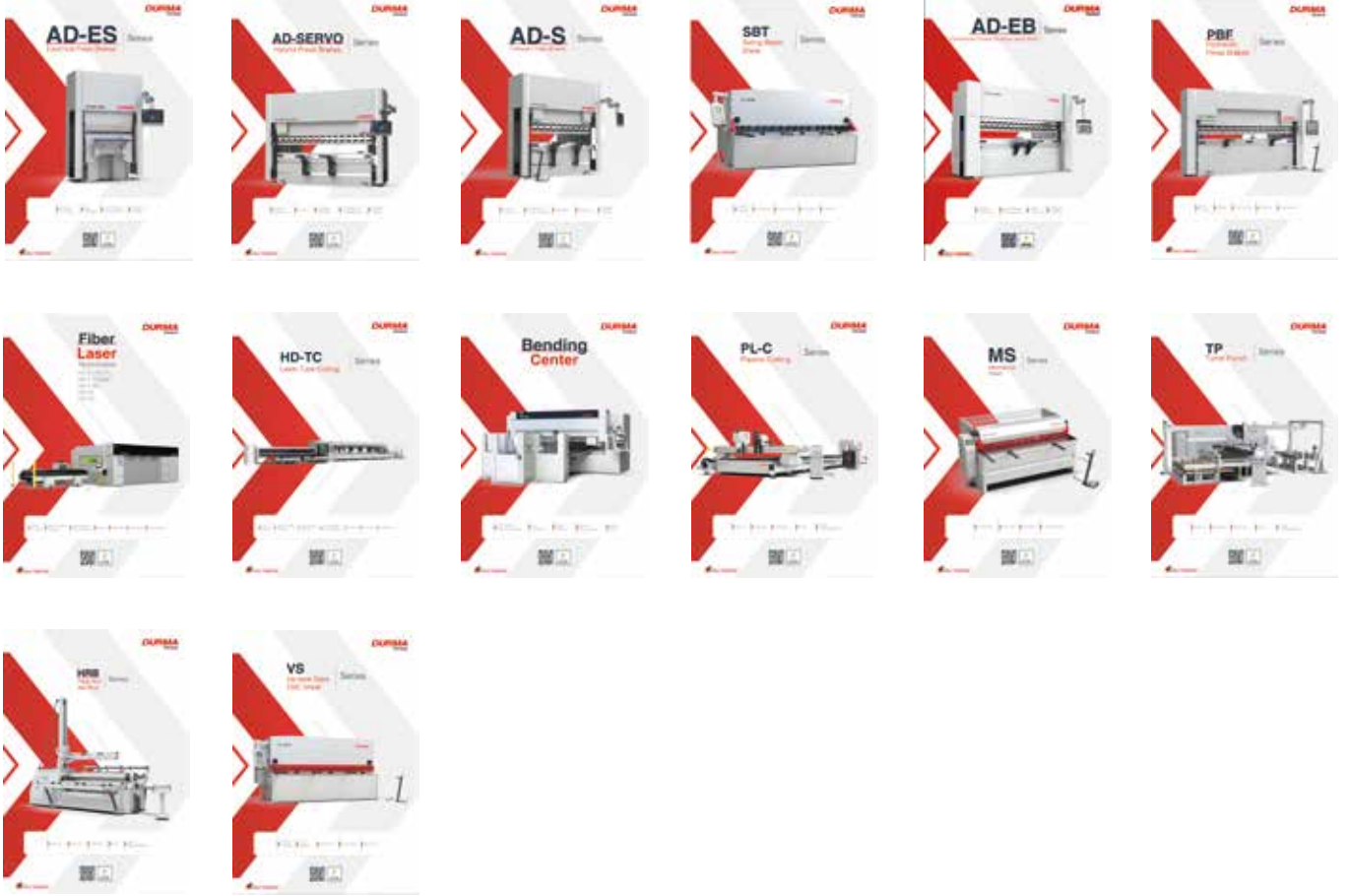
# Product Groups

# DURMA



-  Durma International
-  durmainternational
-  durmaint
-  durmamachines
-  Durmazlar



EN 2024/08/V03



Durmazlar Makina San. ve Tic. A.Ş.  
OSB 75. Yıl Bulvarı Nilüfer-Bursa /  
Türkiye  
P: +90 224 219 18 00  
F: +90 224 242 75 80  
info@durmazlar.com.tr

www.durmazlar.com.tr

Durmazlar Makina San. Tic. A.Ş. has right to change catalogue values and machine technical details without notice.