

# AD-EB Series

Electrical Press Brakes with Belt



Perfect Precision

Low Energy Consumption

High Capacity

Elegant Design



As a total supplier for sheet metal manufacturing with almost 70 years of experience, Durma understands and recognizes the challenges, requirements and expectations of the industry. We strive to satisfy the ever higher demands of our customers by continuously improving our products and processes while researching and implementing the latest technologies

In our three production plants with a total of 1.614.586 ft<sup>2</sup> we dedicate 1,000 employees to delivering high quality manufacturing solutions at the best performance-to-price ratio in the market.



**PRODUCTION IS**  
**MORE EFFECTIVE** NOW



From the innovations developed at our Research & Development Center to the technical support given by our worldwide distributors, we all have one common mission: to be your preferred partner.

**Durmazlar offers it's machines to the world markets under the Durma brand.**



**1**

High technology,  
modern production  
lines



**2**

Top quality  
components



**3**

High quality  
machines designed  
in R&D Centre

# AD-EB

## AD-EB Series Electric Press Brake

### Environment Friendly

DURMA AD-ES CNC PRESS BRAKE serial can provide the production starting from 2500 mm table width to 3050 mm table width. It is also possible to apply different sizes in line with customer demands. The machine body is bolted and processed with precision tables.

The reducer drive system, high torque-resistant bearings provide high precision bending results.



Production is *More Effective Now.*

# ENVIRONMENT FRIENDLY LOW COST HIGH GAIN

- Excellent bending results
- Minimum tool change and adjustment time
- Maximum speed and safety



High Capacity

Robust Body

Perfect Precision

Winning

Ergonomic

## Advantages

- High-energy saving
- Decreased operating costs
- Reduced cooling effort
- Operational reliability
- High availability
- Lower investment Cost
- Future-oriented technology
- Remarkable noise reduction
- Fewer requirement for measures
- Ease of integration of check functions
- Decreased maintenance costs
- Compliance with EU standards

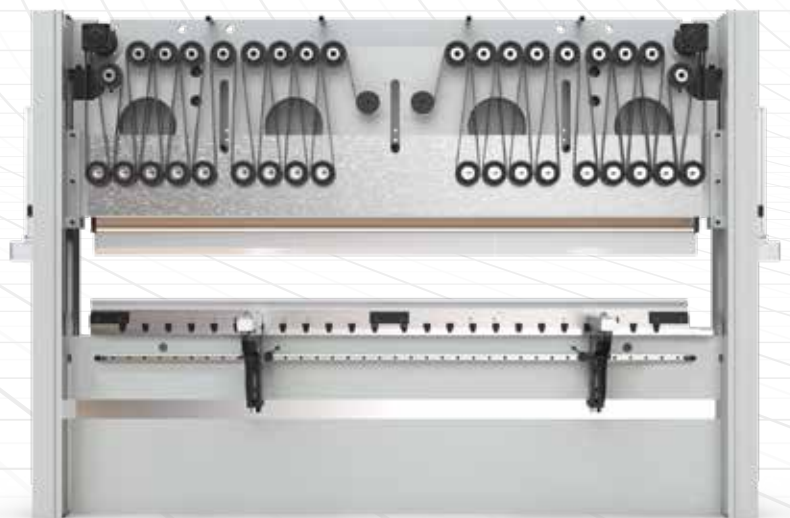

# AD-EB

## HIGH INCREASE IN PRODUCTION EFFICIENCY

Our AD-EB series solutions provide high energy savings to our business with speed, efficiency, quality, and low power consumption.

- Energy saving
- Same consistency in each cycle
- Economic
- Repeatability at high speed





# STRONG BACK GAUGE SYSTEM

- Precise
- Reliable
- Strong

- Fast and high accuracy
- Safe movement
- Long-life linear motion elements
- No maintenance required
- Simple to use, easy to maintain

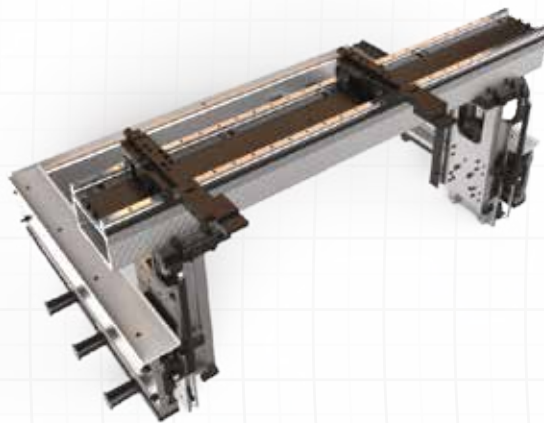

**X 650 X R (AL) BACK GAUGE**

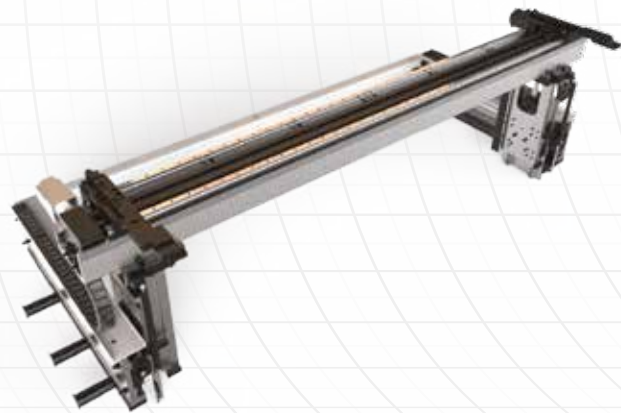

**X 650 X R Z1 Z2 (AL) BACK GAUGE**

- AD-EB back gauge systems are long-lasting, precise, and resistant to impacts.
- The high-speed back gauge system moving with ballscrew is also supported with linear guides.

## Why DURMA Back Gauge?

The most important factor that affects bending quality is the stability and the design of the back gauge. Perfect bending, perfect product is possible through a stable and precise back gauge.

The high-speed back gauge system moving with ballscrew is also supported with linear guides. Thus, long life, precision, and strength against collisions are provided.

The back gauge finger is designed to achieve all types of bendings in maximum stability.

## TOOL HOLDERS AND TOOLS

The bending performance of the machine is increased by using a High-Quality European type clamping system and ease of use is provided.

The lower body is designed as narrow for Z-type bending and designed in accordance with the European type tool holding system.

DURMA is your solution partner with various tool options.



European Clamping System

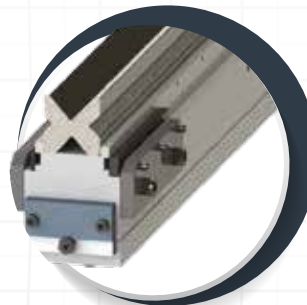

European Type Bottom Tool (4V Die)



Quick Release Clamping

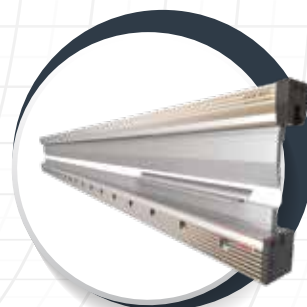

DURMA Hydraulic Holder



DURMA Top Tool Holder

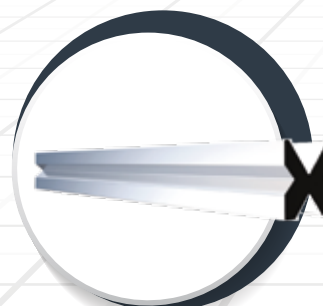

DURMA Multi V Bottom Tool



## SAFE AND PRECISE BENDS WITH TOP QUALITY EQUIPMENT

### ■ CE Safety Systems

Crowning System CNC controlled, motorized crowning system provides perfect result in each point of bending. Your bending differences arising from the material or other factors are calculated by motorized CNC crowning system and the perfect result is achieved.



CE Laser Safety System

### ■ Aluminum Sheet Supporting System

The strong front arm can be moved to the right and left and fixed at the desired position with a linear slide and roller system. With aluminum miter and bar support, the sheet material can be easily moved to the machine.



Front Sheet Support System with Linear Guide and Aluminum Miter



## BENDING IS EASIER NOW

On the control unit's powerful simulation screen, the bending position can be monitored instantaneously and the bending parameters can interfere. The blanking of the parts to be bent in CNC, back gauge positions, bending order, the compatibility of the bending parts with the stroke, and the tools required for bending angles are automatically performed by the control unit on condition that the material information is defined.

There is also the possibility to monitor the bends in three dimensions according to the type of the control unit and whether there is any collision during the bending or not.

### ■ DA-66S (Standard)



- 2D graphical touch screen programming mode
- 3D visualisation in simulation and production
- 24" high resolution colour TFT
- Full Windows application suite
- Delem modusys compatibility
- USB, peripheral interfacing
- User specific application support within the controllers multitasking environment
- Sensor bending & correction interface
- Profile - TL - software

### ■ DA-69S (Optional)



- 24" TFT screen, 1920 x3080 pixels, 32 bit colour,
- Real-time Linux embedded OS
- Full touch screen control
- Storage capacity 2 GB
- Network connectivity
- Delem modusys compatible
- Tandem operation 2D/3D real-scale product programming and visualisation
- Automatic bending sequence calculation for 2D/3D
- DXF part & tool import support

Production is *More Effective Now.*

■ DURMA Angle Measurement System

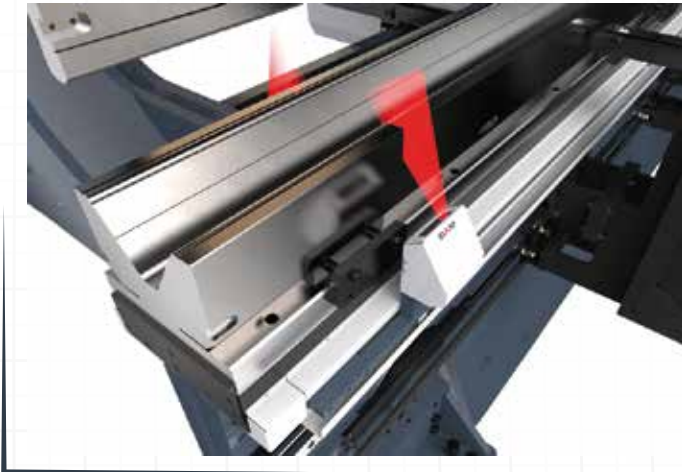

■ Automatic AP3 - AP4 Sheet Follower

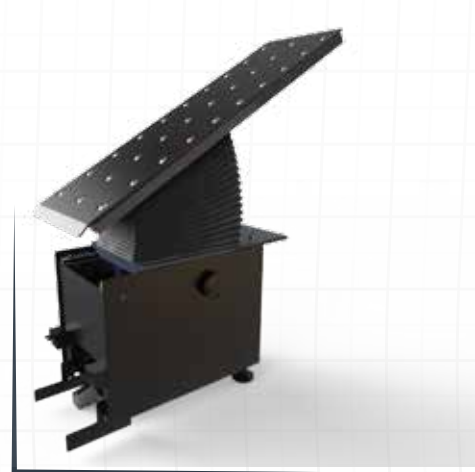

■ Robotic System of Applications



# AD-EB

## Advantages Compared to the Classical Press Brake

### PRESS GROUP

- Motor - Reducer Coupled
- Belt System - Pulley Tackle System

### Equipment Advantages

- Simpler Drive Group
- Fewer Components
- Easy and Fast Assembly
- Easy and Quick Maintenance
- Hydraulic Oil-Free Drive System
- Precision bends using motorized crowning





## AD-EB Series Technical Details

Machine Types	Bending Force	Bending Length	Distance Between Columns	Stroke	Daylight	Working Height	Approaching Speed	Bending Speed	Return Speed	Back Gauge X Axis Length	Back Gauge R Axis Length	Length	Width	Height	Weight
Unit	tustons	ft	ft	ft	ft	ft	inch/sec	inch/sec	inch/sec	ft	inch	ft	ft	mm	lbs
AD-EB 2580	88	8' 4"	9' 3,8"	1' 0,6"	1' 7,7"	3' 5,9"	4,1	0,4-0,8*	4,1	2' 1,6"	10"	12' 1,7"	7' 2,6"	8' 2,4"	14110
AD-EB 30135	149	10'	10' 11,5"	1' 0,6"	1' 7,7"	3' 5,9"	4,1	0,4-0,8*	3,9	2' 1,6"	10"	13' 9,3"	7' 2,6"	8' 4,4"	16094

\*According to CE Norm, the bending speed should be a maximum of 0,4 inch/sec, except for robot-aided use.

## Standard & Optional Equipment

### Standard Equipment

- Control Unit - DA-66S
- Y1, Y2, X, R (4 -Axis) X=650mm Back Gauge (AI - Double Guide)
- F.AKAS LC 5 Safety system
- Servo motor back gauge & linear guided & ballscrew system (X-R)
- European type tool holding system
- Sliding front arms (With T-Slot and stopper) With full-length linear slide
- World quality electric equipment
- Motorised crownin syetem (Eklenecek)

### Optional Equipment

- Control Unit - DELEM - 69S touch screen
- Motorised X,R,Z1,Z2 Axis back gauge system
- X = 650mm X, R, Z1, Z2, Delta X +/- 125 mm CNC
- Controlled (AL) X axis = 1000 mm - Back protection with light barriers
- Durma laser angle measurement
- DBEND 3D bending edit and simulation
- Quick Clamping System
- Hydraulic tool holding system
- Robot integration
- Additional back auge finger and additional sliding front arms
- Central lubrication manual/automatic
- Special packaging for overseas shipments

**AD-EB**

# **PRODUCTION IS MORE EFFECTIVE NOW**

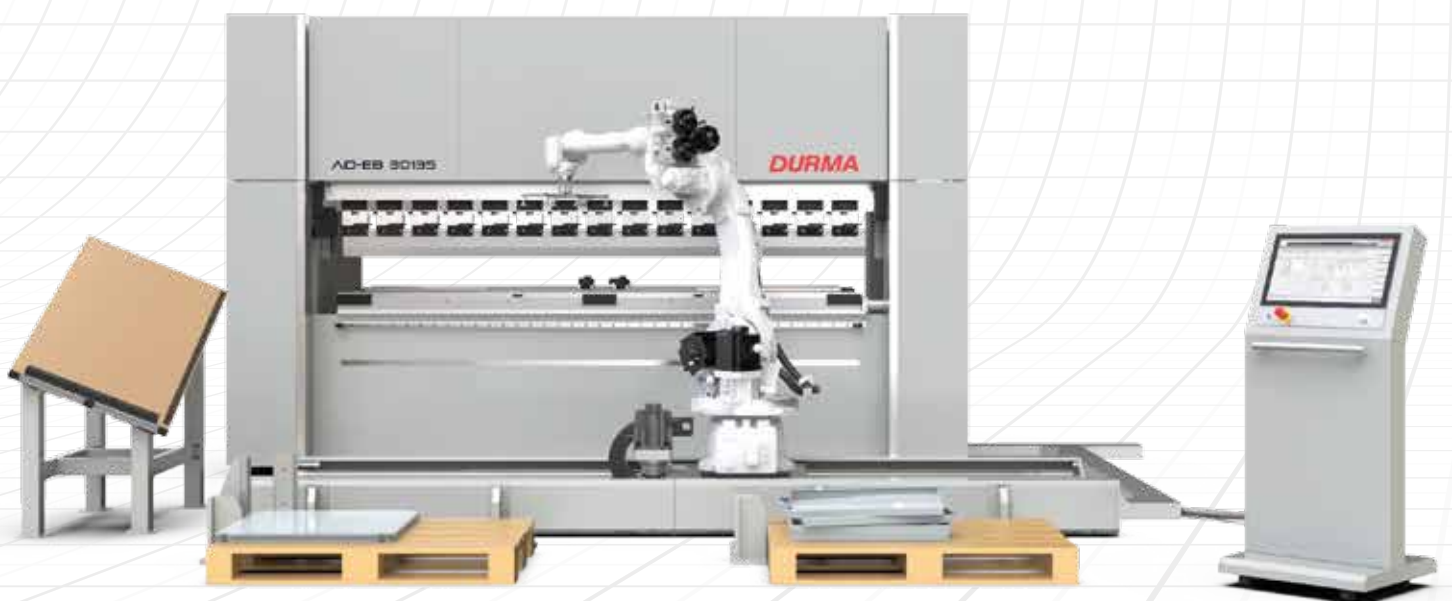

Production is *More Effective Now.*

# FAST ON SERVICE AND SPARE PARTS

DURMA provides the best level of service and spare parts with qualified personnel and spare parts in stock. Our experienced and professional service personnel are always ready at your service. Our professional training and application enriched courses will give you an advantage to use our machinery.





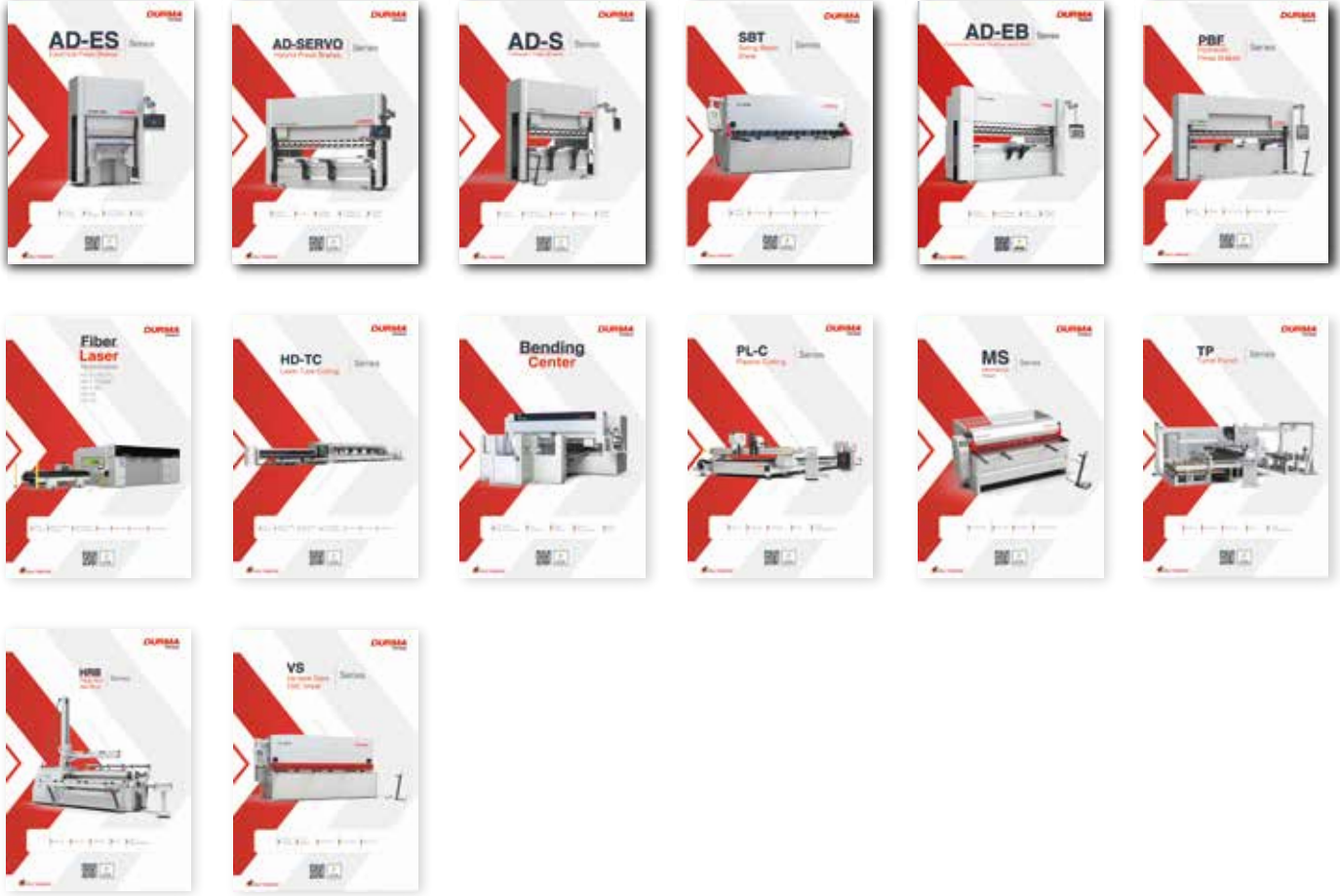

# Product Groups

# DURMA



Durmazlar Makina San. Tic. A.Ş. has right to change catalogue values and machine technical details without notice.

-  Durma International
-  durmainternational
-  durmaint
-  durmamachines
-  Durmazlar



INCH 2024/08/V03



Durmazlar Makina San. ve Tic. A.Ş.  
OSB 75. Yıl Bulvarı Nilüfer-Bursa /  
Türkiye  
P: +90 224 219 18 00  
F: +90 224 242 75 80  
info@durmazlar.com.tr  
www.durmazlar.com.tr